

Kürzen der Stahlflex-Leitung How to cut the braided hose Comment couper la durite tressée?

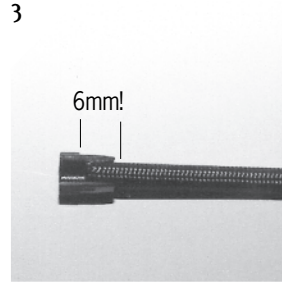

the passion people

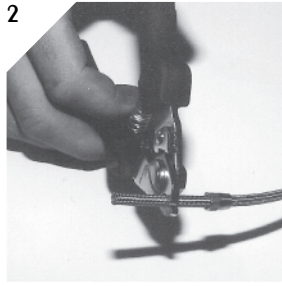
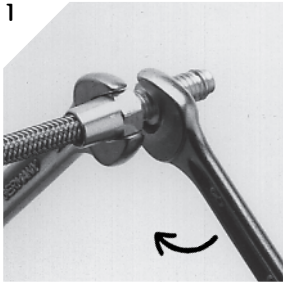

Bowdenzugzange zum Kürzen verwenden!
Use a cable cutter to shorten the hose!
Utiliser une pince coupe câble pour raccourcir la durite!

Achtung:
Überlassen Sie das Kürzen der Leitung im Zweifelsfalle Ihrem MAGURA-Fachhändler.

Attention:
The cutting of the hose should only be done by your bike shop.

Attention:
Le raccourcissement de la durite tressée ne doit être fait que par votre spécialiste MAGURA agréé.

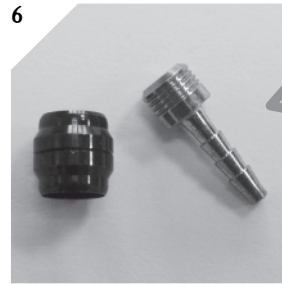
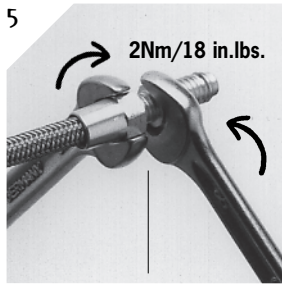
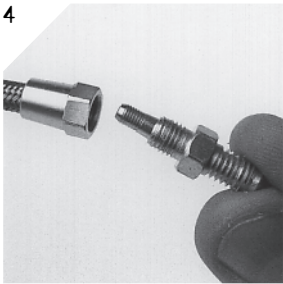

Nicht überdrehen!
Do not overtighten!
Ne pas trop serrer!

Bei der Stahlflexleitung nicht notwendig!
Not necessary with the braided hose!
Ne pas nécessaire avec la durite tressée!

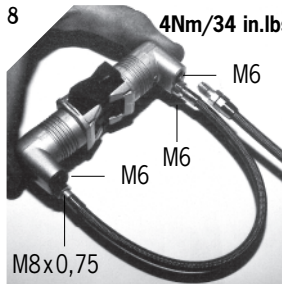
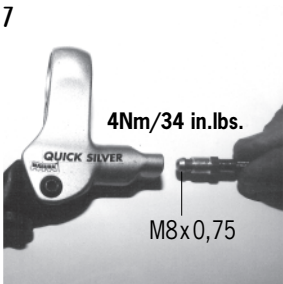

MAGURA: Kompatibel?/compatible?

HS 11	-
HS 12	✓
HS 22	✓
HS 24	✓
HS 33	✓
HS 66	-
HS 77	-

Anschluß Felgenbremsen
rim brake connection
montage sur les freins sur jante

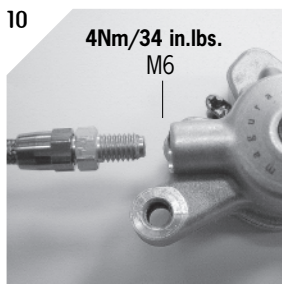
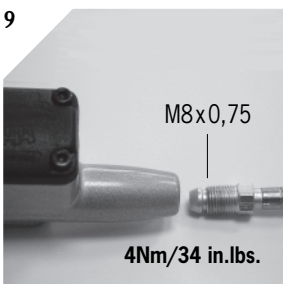

MAGURA:	Kompatibel?/compatible?	0°-Kit (0721 203: 1700mm) (0721 386: 2500mm)	90°-Kit (0721 337: 1700mm) (0721 641: 2500mm)
Gustav M	✓	✓	✓
Marta/ Marta SL	✓	-	-
Louise FR	✓	✓	✓
Louise	✓	-	-
Clara 2000 *	-	-	-
Clara 2001/02	✓	-	-
Julie	✓	-	-

Anschluß Scheibenbremsen
disc brake connection
montage sur les freins à disque

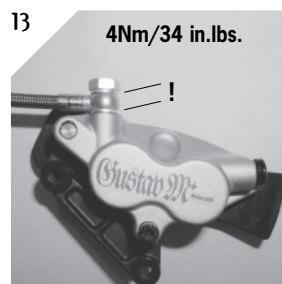
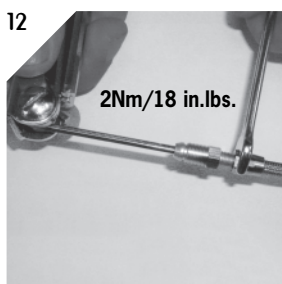

Dichtscheiben nicht vergessen!
Do not forget washers!
Ne pas oublier les entretoises!

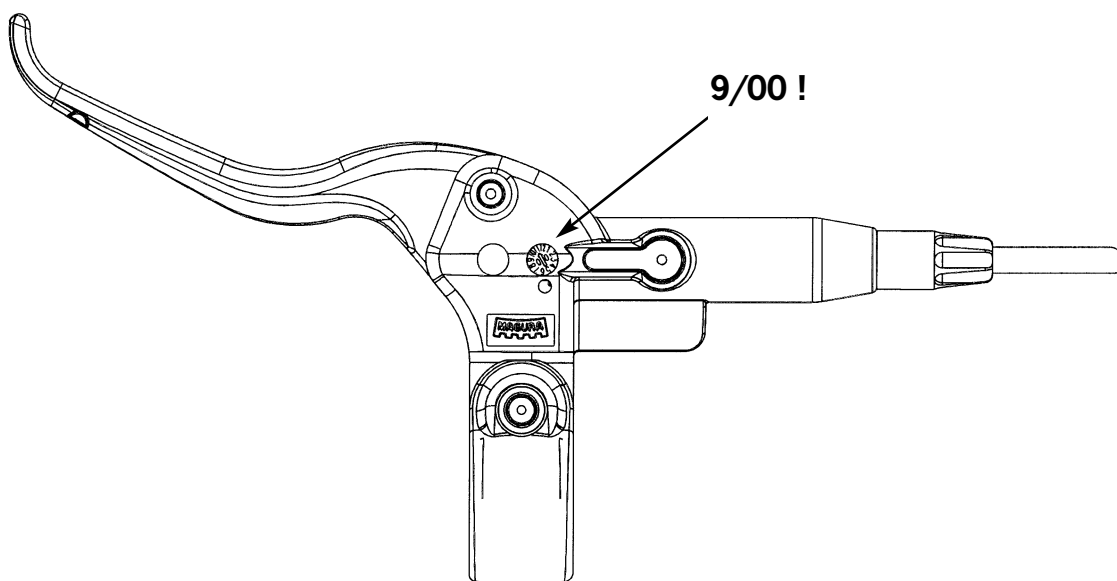

Clara-Bremsgriffe:

Achten Sie auf den Fertigungstempel auf der Unterseite des Bremsgriffs. Erst ab Fertigungsmonat **9/2000** sind Clara-Bremsgriffe mit der Stahlflex-Leitung kompatibel!

Clara brake levers:

Watch out for the production month indicated at the lower side of the brake lever. Only from **9/2000** onwards the Clara brake levers are compatible with the braided hose.

Poignées Clara

Vérifier le mois de production au dessous de la poignée. La poignée est compatible avec la durite tressée à partir de **9/2000!**

Ausstattungsänderungen und Irrtümer vorbehalten!
Specifications are subject to change without
prior notice!

Les caractéristiques des produits peuvent être
modifiés sans préavis!